

DAVICULTOR

EN

Cultivators with hydraulic width adjustment and in-row weeder

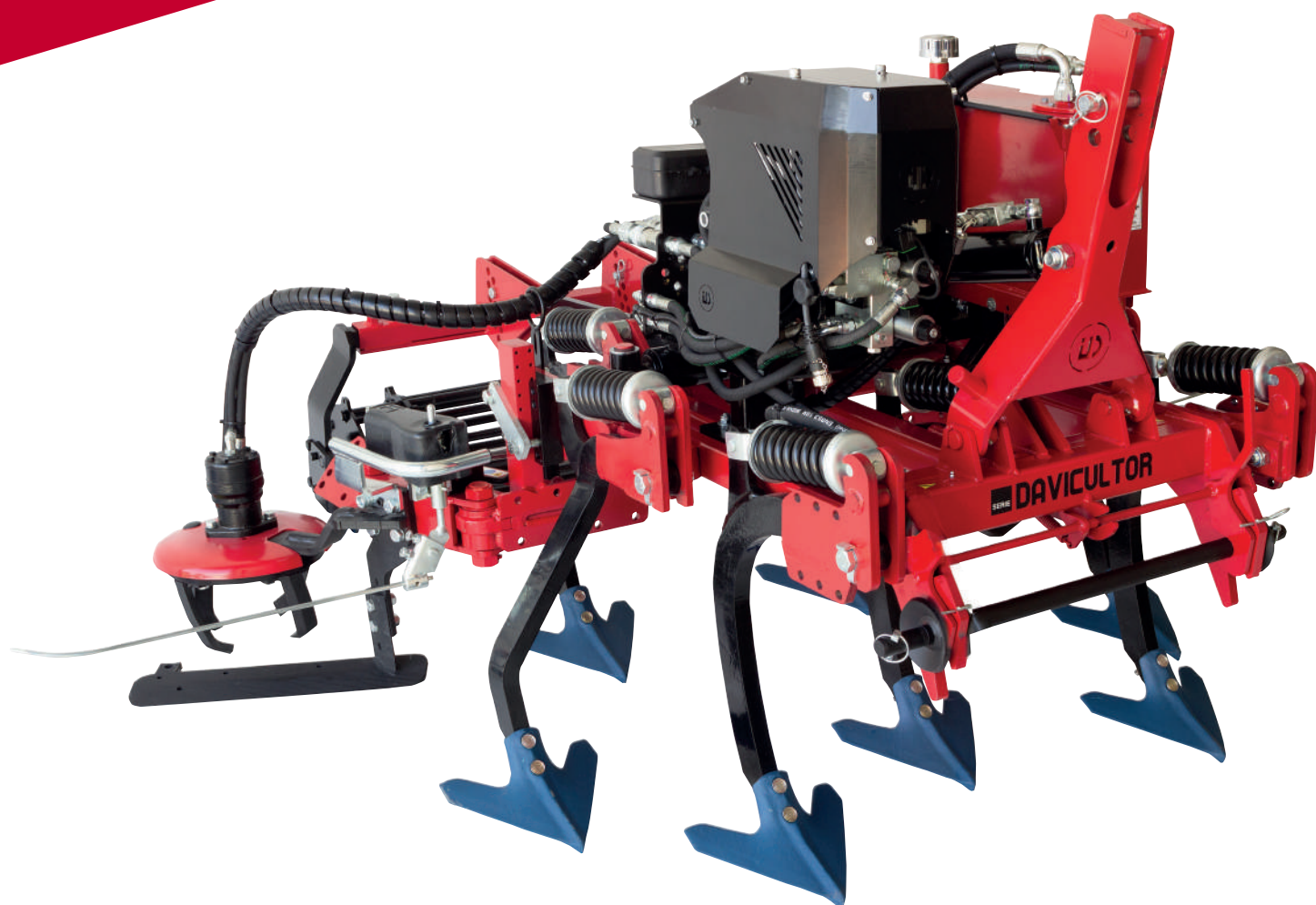

DAVID
SMART FARMING SOLUTIONS

SERIE

DAVICULTOR



Cultivators with hydraulic width adjustment and in-row weeder, specially designed for primary tillage in vineyards and orchards.

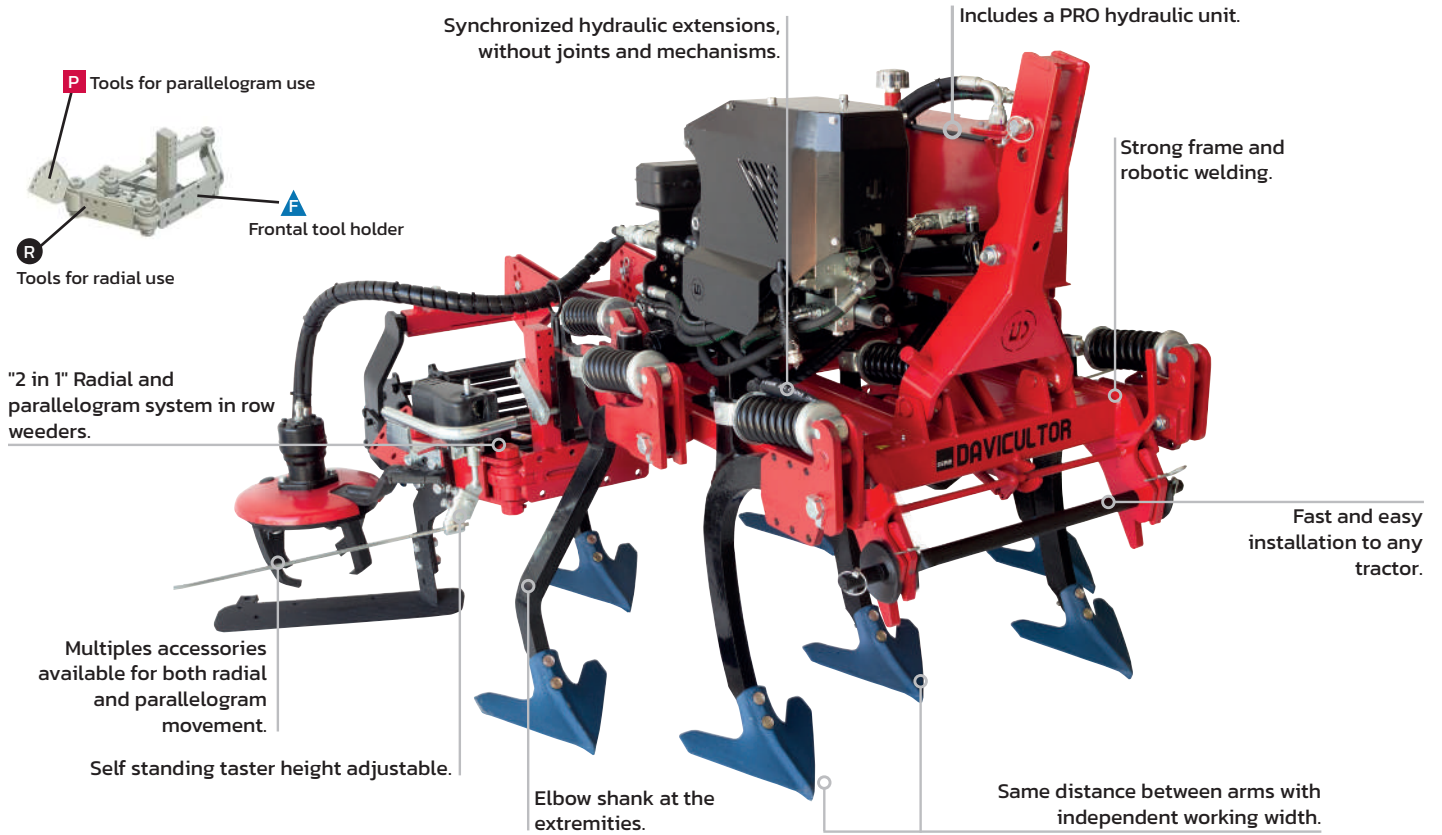

PICTURE MODEL:
CXH7-P + TH-EC + RA30-12-P

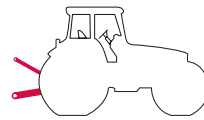

Versatility

- The widest range of products and accessories on the market. A custom configuration to suit your needs.
- Multiple tools for the in-row weeder that allow both surface working and tillage up to 20 cm deep.
- The ID-CONTROL joystick allows to control all the machines manufactured by ID David and equipped with the ID-PLUS or ID-MICRO technology.

Exclusivity

- The exclusive undervine weeder that combines the "parallelogram-radial" movement.
- Opportunity to work between plants starting from 1 cm diameter thanks to our adjustable and progressive electronic sensor, the arm is moving at the right time to save the plant.
- The special position of the tines makes possible to work always at the same distance between them, whether the cultivator is completely extended or narrowed, avoiding jamming.

Effectiveness

- Time is valuable, it is possible to work up to 12 km/h with a standard soil conditions.
- The easy adjusting of hydraulic pressure of the in row weeder assured a perfect work in any type of soil.
- The reinforced structure, hydraulically width adjustable, and the special tines enable to work with different types of ploughshare reaching a working depth of up to 25 cm.

Reliability

- Components and materials of high quality from certified manufacturers.
- The maintenance is reduced to a minimal due to the total absence of joints and ball joints as well as the heavy duty width extensions.
- Experience in the manufacture of electrohydraulic undervine weeders since 1974.

Safety

- As standard all models are fitted with an exclusive safety locking system in case of faults.
- Enables route deviations up to 30 cm in the plantation rows.
- Our equipment incorporates easy, comfortable and safe tool replacement systems.

Sustainability

- Ecological alternative to the use of herbicides.
- The low power required allows the use of small tractors with a lower carbon footprint.
- Improves the structure and porosity of the soil.

Standard Equipment

- Includes a PRO hydraulic unit.
- Anti-shock sensor protector.
- Kit of Shank + Spring + Plowshare DAVID by Bellota.
- Hydraulic pressure regulator.
- Electro hydraulic in row weeder.
- Tool kit for sensor regulation.
- Arm "D" and Plough blade to weed manufactured in boron steel.
- Quick connect kit for power tools.
- Security system under damages.
- Standard boron steel plowshare, hardness 50Hrc.
- Adjustable rear roller in height and width.
- Hydraulic width adj. direct to tractor (not available in fixed models).
- Quick attachment.

Remote control type

ID-PLUS

- Includes ID-CONTROL multifunction joystick.
- Includes ON-OFF of powered tools.
- Includes an electronic microcontroller: allows software updates at any time.
- Up to 5 additional electro-hydraulic functions.
- Includes a modular electro-hydraulic system: it allows to increase the number of electro-hydraulic functions.

ID-MICRO







- ! NOT included the ID-CONTROL multifunction joystick.
- Only for customers who already have the ID-CONTROL multifunction joystick.
- Includes ON-OFF of powered tools.
- Includes an electronic microcontroller: allows software updates at any time.
- Up to 5 additional electro-hydraulic functions.
- Includes a modular electro-hydraulic system: it allows to increase the number of electro-hydraulic functions.

ID-BASIC

- Includes an electric control box.
- Max. 1 additional electro-hydraulic function to choose between: PI-002 / PI-004 / EH-EC / TH-EC / IH-EC
- ! NOT allowed any updates of electro-hydraulic functions.

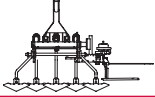
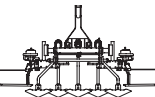
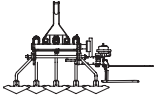
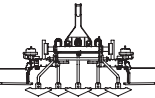

ID-PLUS DUAL

- Includes ID-CONTROL multifunction joystick.
- Includes ON-OFF of powered tools. Includes cooler and double pump.
- Includes an electronic microcontroller: allows software updates at any time.
- Up to 4 additional electro-hydraulic functions.
- Includes a modular electro-hydraulic system: it allows to increase the number of electro-hydraulic functions.

							
DAVICULTOR	cm.	ud	m	REF.	REF.	REF.	REF.
FIX MANUAL EXTENSION 1 IN ROW WEEDER 	49	2	≥ 1,10	CXF2-1-D	CXF2-2-D	CXF2-3-D	CXF2-4-D
	49	3	≥ 1,40	CXF3-1-D	CXF3-2-D	CXF3-3-D	CXF3-4-D
	55	5	≥ 1,90	CXF5-1-D	CXF5-2-D	CXF5-3-D	CXF5-4-D
FIX MANUAL EXTENSION 2 IN ROW WEEDER 	49	2	1,10-1,50	CXF2-1-P	CXF2-2-P	CXF2-3-P	CXF2-4-P
	49	3	1,40-1,90	CXF3-1-P	CXF3-2-P	CXF3-3-P	CXF3-4-P
	55	5	1,90-2,35	CXF5-1-P	CXF5-2-P	CXF5-3-P	CXF5-4-P
HYDRAULIC EXTENSION 1 IN ROW WEEDER 	55	7	≥ 2,05	CXH7-1-D	CXH7-2-D	CXH7-3-D	CXH7-4-D
	55	7	≥ 2,30	CXH7A-1-D	CXH7A-2-D	CXH7A-3-D	CXH7A-4-D
	55	9	≥ 2,25	CXH9-1-D	CXH9-2-D	CXH9-3-D	CXH9-4-D
	55	9	≥ 2,50	CXH9A-1-D	CXH9A-2-D	CXH9A-3-D	CXH9A-4-D
	55	11	≥ 2,80	CXH11-1-D	CXH11-2-D	CXH11-3-D	CXH11-4-D
	65	11	≥ 3,25	CXH11A-1-D	CXH11A-2-D	CXH11A-3-D	CXH11A-4-D
	65	13	≥ 3,50	CXH13-1-D	CXH13-2-D	CXH13-3-D	CXH13-4-D
HYDRAULIC EXTENSION 2 IN ROW WEEDER 	55	5	1,95-2,35	*CXH5-1-P	*CXH5-2-P	*CXH5-3-P	*CXH5-4-P
	55	7	2,05-2,55	CXH7-1-P	CXH7-2-P	CXH7-3-P	CXH7-4-P
	55	7	2,30-2,80	CXH7A-1-P	CXH7A-2-P	CXH7A-3-P	CXH7A-4-P
	55	9	2,25-2,95	CXH9-1-P	CXH9-2-P	CXH9-3-P	CXH9-4-P
	55	9	2,50-3,20	CXH9A-1-P	CXH9A-2-P	CXH9A-3-P	CXH9A-4-P
	55	11	2,80-3,50	CXH11-1-P	CXH11-2-P	CXH11-3-P	CXH11-4-P
	65	11	3,25-3,95	CXH11A-1-P	CXH11A-2-P	CXH11A-3-P	CXH11A-4-P
	65	13	3,50-4,20	CXH13-1-P	CXH13-2-P	CXH13-3-P	CXH13-4-P

*This model hydraulically extends only the two undervines.

Technical details

DAVICULTOR		X			L	W	H
REF.		m	kg	HP	m	m	m
FIX MANUAL EXTENSION 1 IN ROW WEEDER	CXF2-D	≥ 1,10	315	20	1,90	0,70	1,30
	CXF3-D	≥ 1,40	345	25	1,50	0,90	1,30
	CXF5-D	≥ 1,90	425	50	1,60	1,40	1,30
FIX MANUAL EXTENSION 2 IN ROW WEEDER	CXF2-P	1,10-1,50	385	25	1,90	0,70	1,30
	CXF3-P	1,40-1,90	405	30	1,50	0,90	1,30
	CXF5-P	1,90-2,35	485	55	1,60	1,40	1,30
HYDRAULIC EXTENSION 1 IN ROW WEEDER	CXH7-D	≥ 2,05	625	55	1,65	1,70	1,30
	CXH7A-D	≥ 2,30	635	60	1,65	1,85	1,30
	CXH9-D	≥ 2,25	710	70	1,65	1,90	1,30
	CXH9A-D	≥ 2,50	720	75	1,65	2,05	1,30
	CXH11-D	≥ 2,80	800	85	1,65	2,45	1,30
	CXH11A-D	≥ 3,25	810	90	1,65	2,60	1,30
	CXH13-D	≥ 3,50	890	95	1,65	2,95	1,30
HYDRAULIC EXTENSION 2 IN ROW WEEDER	CXH5-P	1,95-2,35	505	55	1,60	1,40	1,30
	CXH7-P	2,05-2,55	690	60	1,65	1,70	1,30
	CXH7A-P	2,30-2,80	700	65	1,65	1,85	1,30
	CXH9-P	2,25-2,95	775	75	1,65	1,90	1,30
	CXH9A-P	2,50-3,20	785	80	1,65	2,05	1,30
	CXH11-P	2,80-3,50	860	90	1,65	2,45	1,30
	CXH11A-P	3,25-3,95	910	95	1,65	2,60	1,30
	CXH13-P	3,50-4,20	955	100	1,65	2,95	1,30

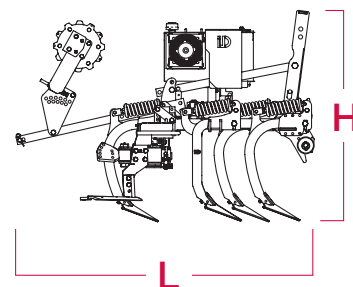
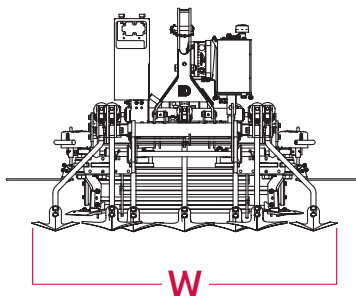
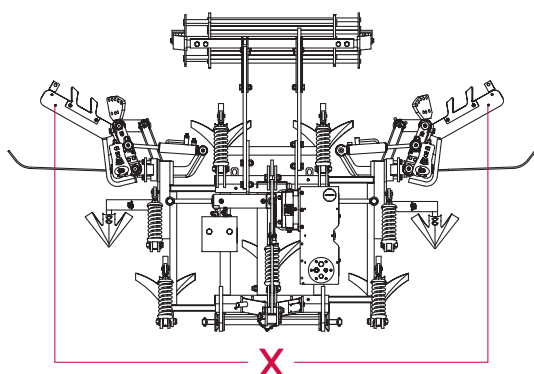



Drawbar

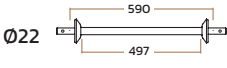
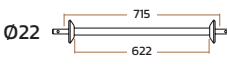
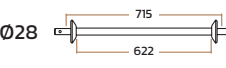
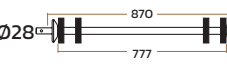

S Standard
 • Optional
 (Replace standard)

					
		REF. BE-2259	REF. BE-2271	REF. BE-2871	REF. BE-2887
FIX MANUAL EXTENSION 1 IN ROW WEEDER	CXF3-D	S			
	CXF5-D		•	S	
FIX MANUAL EXTENSION 2 IN ROW WEEDER	CXF3-P	S			
	CXF5-P		•	S	
HYDRAULIC EXTENSION 1 IN ROW WEEDER	CXH7-D		•	S	
	CXH7A-D		•	S	
	CXH9-D		•	S	•
	CXH9A-D		•	S	•
	CXH11-D		•	S	•
	CXH11A-D		•	S	•
	CXH13-D		•	•	S
HYDRAULIC EXTENSION 2 IN ROW WEEDER	CXH5-P		•	S	
	CXH7-P		•	S	
	CXH7A-P		•	S	
	CXH9-P		•	S	•
	CXH9A-P		•	S	•
	CXH11-P		•	S	•
	CXH11A-P		•	S	•
	CXH13-P		•	•	S





Cultivator Accessories and Options







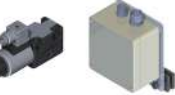

	DESCRIPTION	OBSERVATIONS		REF.
	Wide plow blade with rib 330x8mm + screws	Standard included	Unitary	GA-1
	Plow blade with rib 275x8mm + screws		Unitary	GN-1
	Double coil tines 70x8mm + screws		Unitary	CM-1
	Suppletory wings 280x8mm + screws	Adaptable to fits in double coil tines	Unitary	AL-1
	Boot+chisel+flat grid 400mm	Adaptable accessory arm		BFR400
	Additional extension (female-female)		120 mm	SE1-HH
	Cultivator reinforced spring	Replace standard spring	Unit	MRC
		Extra	Unit	MRC-1
	Hydraulic 3 point hitch	Directly to the tractor		TH-DT
		Electric control in cab (1 electrovalve)		TH-EC
	Solenoid valve for hydraulic extension Integrated in control box			EH-EC
	Pair of smooth metallic wheels frontal mounting	Adjustable in height		RMD-P
	Adjustable roller Ø27cm	0,60 m	CXF2	ROSE
		0,97 - 1,35 m	CXF3-CXF5	R1SE
		1,17 - 1,57 m	CXH7-CXH7A	R2SE
		1,56 - 2,36 m	CXH9-CXH9A	R4SE
		1,76 - 2,76 m	CXH11 / 11A	R5SE
		2,31 - 3,31 m	CXH13 / 13A	R6SE
	*Included as standard Height and width			
	Roller Ø40cm fix helical	0,82 m	CXF3	RFOSY
		1,05 m	CXF5	RF1SY
		1,40 m	CXH7-CXH7A	RF2SY
		1,75 m	CXH9-CXH9A	RF4SY
		2,25 m	CXH11 / 11A	RF5SY
		2,50 m	CXH13 / 13A	RF6SY
	*Replaced the adjustable Ø27 roller Adjustable in height			
	Rear plank + Arms + Chains	1,75 m		TT175
		2,25 m		TT225
		2,50 m		TT250
		2,75 m		TT275



	DESCRIPTION	OBSERVATIONS		REF.
	Floating barb rake	0,88 m	CXF3	RPF3
		0,88 - 1,46 m	CXF5	RPF5
		1,48 - 2,06 m	CXH7-CXH7A	RPF7
		1,64 - 2,36 m	CXH9-CXH9A	RPF9
		2,24 - 2,96 m	CXH11 / 11A	RPF11
		2,70 - 3,41 m	CXH13 / 13A	RPF13
	Adapted barb rake behind the roller	0,88 m	CXF3	RP3
		0,88 - 1,46 m	CXF5	RP5
		1,48 - 2,06 m	CXH7-CXH7A	RP7
		1,64 - 2,36 m	CXH9-CXH9A	RP9
		2,24 - 2,96 m	CXH11 / 11A	RP11
		2,70 - 3,41 m	CXH13 / 13A	RP13

Pre-installations and updates Accessories and Options

	DESCRIPTION	OBSERVATIONS		REF.
	Upgrade kit for tools quick coupling			KC-002
	Pre-installation in-row weeder left side/ electrohydraulic system			PI-001
	Pre-installation solenoid valve	1 extra function double acting on/off motorized tools	for ID-BASIC	PI-002 PI-004





Undervine weeders Accessories and Options

	DESCRIPTION	OBSERVATIONS		REF.
	Standard oil cooler	Adaptable to PRO hydraulic power plant	Intake 12V	A15-01-PRO
	Pressure filter kit + oil cooler	Replaces hydraulic power plant . Not available for ID-PLUS DUAL.	Intake 12V Tractor plugs connection.	 +2 KFP-03
	Hydraulic side slope correction for in-row weeders	Directly to the tractor	Unit	 +2 IH-DT
	*Increases working width of 10 cm Inclination: + 21°, -10°	Electric cabine	Unit	IH-EC
	Grass bend down system		Right	STH-D
			Pair	STH-P
	Ultrasensible kit for sensitive sensor	Ideal vineyards ≤ 1 cm	Unit	KU-1
	Reinforced in row weeder cylinder for hard soil	Replaces standard cylinder. Recommended oil cooler.	Unit	CIA-R

	DESCRIPTION	OBSERVATIONS	REF.
	Distance Control with cable	for ID-PLUS / ID-MICRO	Right MD1-D
			Pair MD1-P
		for ID-BASIC	Right MD2-D
			Pair MD2-P
	Electrohydraulic kit for quick-connection (connection-disconnection)	In row weeder connection-disconnection	Right KER-IA-D
		Not available for ID-BASIC	Pair KER-IA-P





Undervine weeders









Tools for PARALLELOGRAM USE P







	DESCRIPTION	OBSERVATIONS	REF.
	Shoot remover kit + Sensor rod + String spool 250 mm working width	CXH-3 CXH-5	DBR25-11-D
		CXH-7	Right DBR25-5-D
		CXH-9	
		CXH-11 CXH-13	
		CXH-3 CXH-5	Pair DBR25-11-P
		CXH-7	
		CXH-9	
		CXH-11 CXH-13	
	*Recommended oil cooler Available only for vineyards with at least 40 cm free to the ground or to any obstacle		DBR25-7-P
	Arm B + fixed ploughshare + Sensor rod kit	310x480x400mm	Right BB-VFD
			Pair BB-VFP
	Arm C + adjustable ploughshare + sensor rod kit	410x540x430mm	Right BC-VRD
			Pair BC-VRP
	Arm E + fixed ploughshare with ridging element + sensor rod kit		Right BE-VFD
			Pair BE-VFP
	Retractable extra cleaner blade with spring for ploughshare		Right EM-D
			Pair EM-P

Undervine weeders

Tools for RADIAL USE R

	DESCRIPTION	OBSERVATIONS	REF.
	Arm D + weeding blade + sensor rod kit	Standard included	Right BD-CPD
			Pair BD-CPP
	Kit right weeding blade + sensor rod		Cut 49 cm RCI49D
			Standard 55 cm RCI55D
			Long 65 cm RCI65D
			Cut 49 cm RCI49P
	Kit pair of weeding blade + sensor rod		Standard 55 cm RCI55P
			Long 65 cm RCI65P
	Kit weeding blade made by Tugstene + sensor rod	Right	Standard 55 cm RCHD55D
	Kit weeding blade made by Tugstene + sensor rod	Pair	Standard 55 cm RCHD55P

☉	DESCRIPTION	OBSERVATIONS	REF.
	Retractable extra cleaner blade "V" for blade	Right	EV-D
		Pair	EV-P
	Blade shovel	Right	VO-D
		Pair	VO-P
	Kit mini reversible plough kit 2 discs Ø13.5" + sensor rod 250 mm working width *Recommended oil cooler and reinforced cylinder	CXH-3 CXH-5	MAD25-11-D
		CXH-7	MAD25-5-D
		CXH-9	MAD25-6-D
		CXH-11 CXH-13	MAD25-7-D
		CXH-3 CXH-5	MAD25-11-P
		CXH-7	MAD25-5-P
		CXH-9	MAD25-6-P
		CXH-11 CXH-13	MAD25-7-P
		CXH-3 CXH-5	MAD35-11-D
		CXH-7	MAD35-5-D
	Kit mini reversible plough kit 3 discs Ø13.5" + sensor rod 350 mm working width *Recommended oil cooler and reinforced cylinder	CXH-9	MAD35-6-D
		CXH-11 CXH-13	MAD35-7-D
		CXH-3 CXH-5	MAD35-11-P
		CXH-7	MAD35-5-P
		CXH-9	MAD35-6-P
		CXH-11 CXH-13	MAD35-7-P
		CXH-3 CXH-5	MAD35-11-D
		CXH-7	MAD35-5-D
		CXH-9	MAD35-6-D
		CXH-11 CXH-13	MAD35-7-D
	Retractable extra cleaner blade for mini harrow disc	Right	EMD-D
		Pair	EMD-P
	Kit Rotary hoe Ø300mm + sensor rod *Possibility of simultaneous use with weeding blade (not included) Recommended oil cooler + reinforced cylinder	CXH-3 CXH-5	RA30-11-D
		CXH-7	RA30-5-D
		CXH-9	RA30-6-D
		CXH-11 CXH-13	RA30-7-D
		CXH-3 CXH-5	RA30-11-P
		CXH-7	RA30-5-P
		CXH-9	RA30-6-P
		CXH-11 CXH-13	RA30-7-P
		CXH-3 CXH-5	RA40-11-D
		CXH-7	RA40-5-D
	Kit Rotary hoe Ø400mm + Sensor rod *Possibility of simultaneous use with weeding blade (not included) Recommended oil cooler + reinforced cylinder	CXH-9	RA40-6-D
		CXH-11 CXH-13	RA40-7-D
		CXH-3 CXH-5	RA40-11-P
		CXH-7	RA40-5-P
		CXH-9	RA40-6-P
		CXH-11 CXH-13	RA40-7-P
		CXH-3 CXH-5	RA50-11-D
		CXH-7	RA50-5-D
		CXH-9	RA50-6-D
			Kit Rotary hoe Ø500mm + Sensor rod *Recommended oil cooler and reinforced cylinder
CXH-3 CXH-5	RA50-11-P		
CXH-7	RA50-5-P		
CXH-9	RA50-6-P		
CXH-11 CXH-13	RA50-7-P		

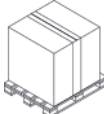
	DESCRIPTION		OBSERVATIONS	REF.		
	Kit string mower Ø400mm + Sensor rod + String reel	CXH-3 CXH-5	Right	GS40H-11-D		
		CXH-7		GS40H-5-D		
		CXH-9		GS40H-6-D		
				CXH-11 CXH-13	Pair	GS40H-7-D
			CXH-3 CXH-5	GS40H-11-P		
			CXH-7	GS40H-5-P		
			CXH-9	GS40H-6-P		
	*Recommended oil cooler	CXH-11 CXH-13		GS40H-7-P		
	Kit string mower Ø500mm + Sensor rod + String reel	CXH-3 CXH-5	Right	GS50H-11-D		
		CXH-7		GS50H-5-D		
		CXH-9		GS50H-6-D		
				CXH-11 CXH-13	Pair	GS50H-7-D
			CXH-3 CXH-5	GS50H-11-P		
			CXH-7	GS50H-5-P		
			CXH-9	GS50H-6-P		
	*Recommended oil cooler	CXH-11 CXH-13		GS50H-7-P		
	Kit string mower Ø600mm + Sensor rod + String reel	CXH-3 CXH-5	Right	GS60H-11-D		
		CXH-7		GS60H-5-D		
		CXH-9		GS60H-6-D		
				CXH-11 CXH-13	Pair	GS60H-7-D
			CXH-3 CXH-5	GS60H-11-P		
			CXH-7	GS60H-5-P		
			CXH-9	GS60H-6-P		
	ID PLUS DUAL control required	CXH-11 CXH-13		GS60H-7-P		
	Kit for modification of string mower with boron steel blades	Only available for new machine	Right	KSGSH-D		
			Pair	KSGSH-P		
	Square string spool	for mower	45 m	BHN-03		
	Nylon string blue spool	for brush head	90 m	BHN-01		
	Packaging	Basic		EMB-1		
		Airfreight- oceanfreight		EMB-3		

Ideal products and services that inspire trust, quality, experience and excellence

Specialized and customized agricultural machines with an attractive design and increasing digitalizations. Our products are oriented towards a biological, environment-friendly and precision farming.



INDUSTRIAS DAVID S.L.U.
C/ Médico Miguel Lucas s/n
CP: 30510, Yecla, Murcia-Spain
Tel.: +34 968 718 119
info@id-david.com

Connect with us.
[instagram.com/iddavid_official](https://www.instagram.com/iddavid_official)
twitter.com/IDdavidslu
[facebook.com/industriasdavid](https://www.facebook.com/industriasdavid)
[linkedin.com/company/id-david](https://www.linkedin.com/company/id-david)
[youtube.com/industriasdavid](https://www.youtube.com/industriasdavid)

www.id-david.com

